

Microcontroller

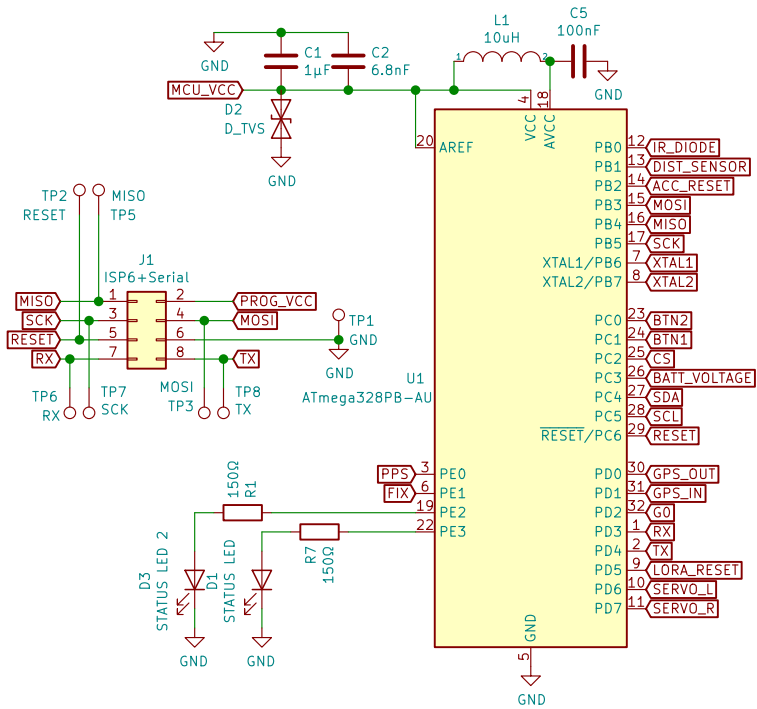

I2C Pullups

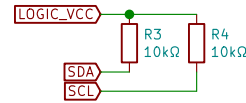

Switches

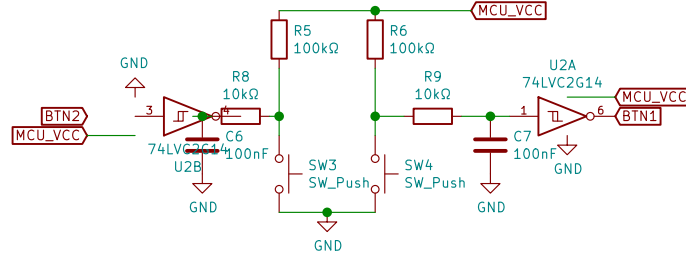
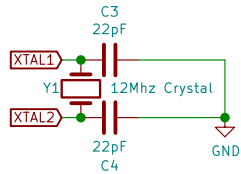
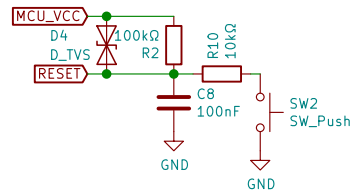

Socket Connector

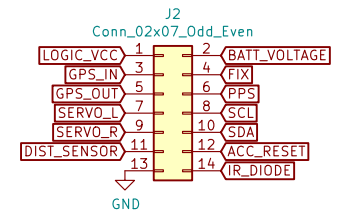

LoRa Header

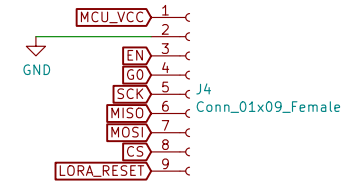

Glider - EFM8 PCB

Sheet: /
File: Glider.sch

Title:

Size: A4 Date:
KiCad E.D.A. kicad (6.0.0-rc1-dev-1198-gbc4e4a484)

Rev: 0.1
Id: 1/1